

МОЩНЫЙ СВЕТОДИОД ARPL-18W-TFA-1919-90

FEATURES

- 2700K, CRI90, 130–140 lm/W
- For indoor general lighting: spotlights, track lights, downlights
- For Industrial lighting: floodlight, high bay light, streetlight
- Low thermal resistance
- RoHS and REACH compliant

SUPERIORITY

- High brightness and light efficiency.
- High color saturation.
- Easy to use with solar and wind energy saving systems.
- Enhanced optical control.
- Greatly reduce the thermal resistance of the light source, improve the weather resistance quality of the light source.
- Reduce the cost of use.
- Reduce maintenance costs.
- No environmental disposal issues.

MECHANICAL DIMENSION

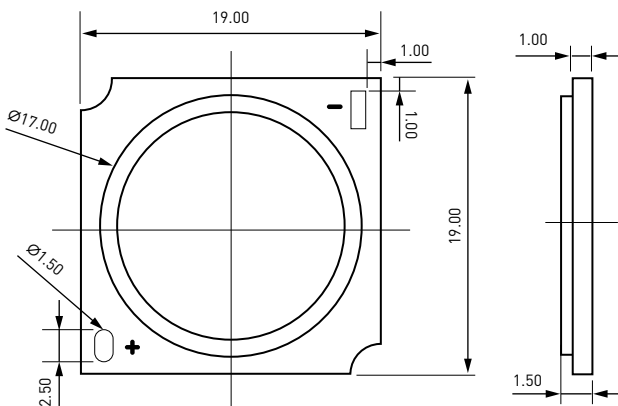

Notes:

1. All dimension tolerance is $\pm 0.2\text{mm}$ unless otherwise noted.

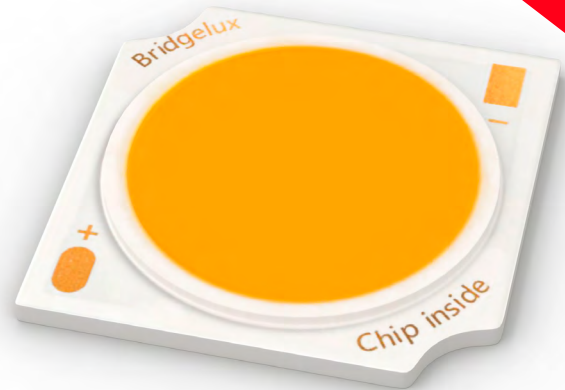

ABSOLUTE MAXIMUM RATINGS

Item	Symb.	Min.	Typ	Max.	Unit
Power	P	-	18	24	W
Forward Voltage	VF	33	35	37	V
Forward Current	I_F	-	480	640	mA
Operating Temperature	TC	-40	-	85	°C
Junction Temperature	T_J	-	-	125	°C
Storage Temperature	T_{STG}	-40	-	105	°C
ESD Sensitivity	ESD	-	-	2000	V
Reverse Voltage	VR	Reverse testing is not allowed			/
Reverse Current	IR				5 uA
Soldering Temperature	T_{SLD}	350 °C/3–5sec			°C/S

Max power and positive current mean the maximum setting value of the bottom temperature of led light source by using the appropriate heat sink.
Connection error and off-limits voltage may damage LED chip.

ELECTRO-OPTICAL CHARACTERISTICS AT $T_J = 25\text{ °C}$

Product	RA	CCT	Luminous Flux (lm) 480mA	Efficacy (lm/W) 480mA	Voltage (V) VF480mA	Part Number
ARPL-18W-TFA-1919- Warm2700-90 (36v, 480mA)	90	2700	3900–4200	130–140	33–37	TP1-1917B- 1206P5-H27A0

Testing environment temperature 25 °C, and CCT and voltage will be changed if tested in different current and environment temperature.
Tolerance among different testing machine: Voltage: $\pm 0.1\text{V}$, Lumen: $\pm 5\%$, CRI: ± 2 , Color coordinate ± 0.005 .

THE REFERENCE MAP COLOR AREA

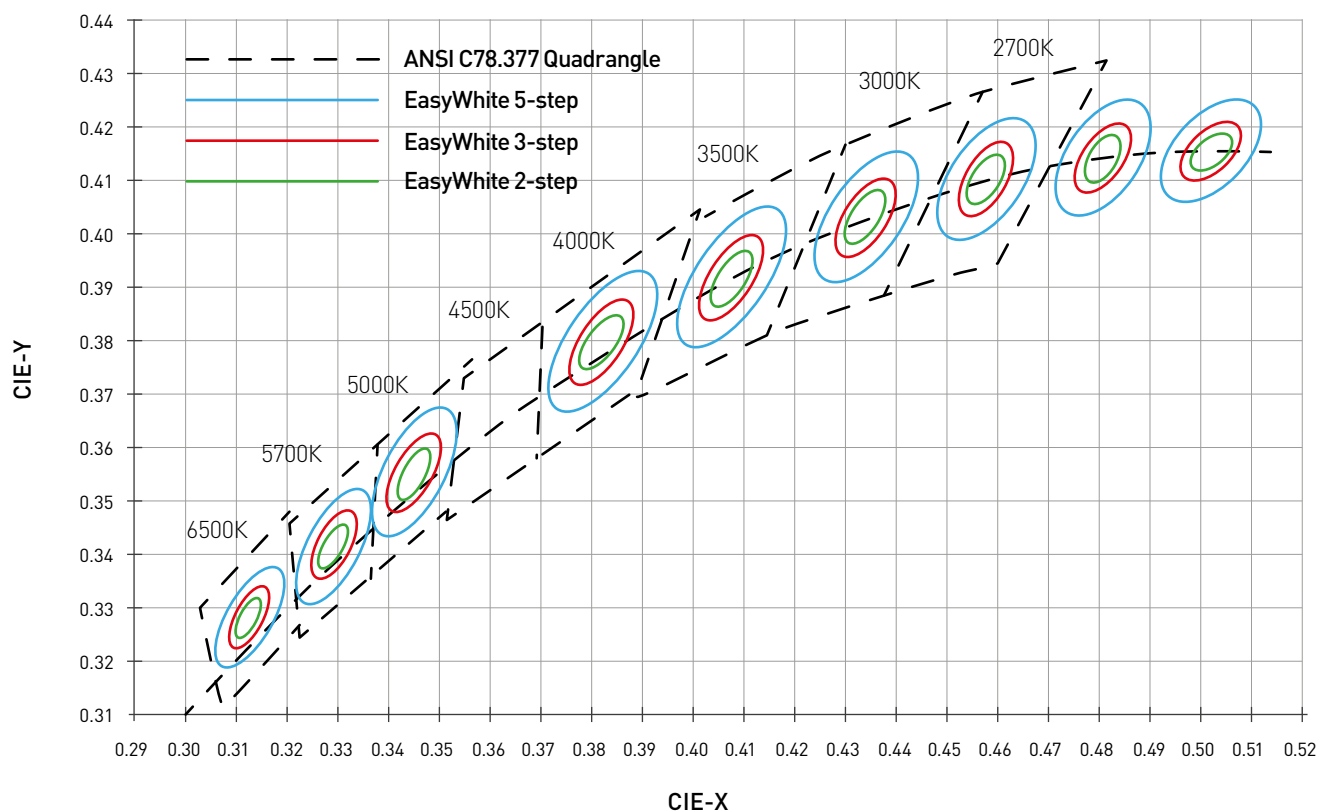

Nominal CCT	Center Point		MAJOR AXIS (a , b)			Ellipse Rotation
	X	Y	2-Step	3-Step	5-Step	
2700 K	0.4578	0.4101	(0.0054, 0.0028)	(0.0081, 0.0042)	(0.0135, 0.007)	53.7

CHARACTERISTIC CURVES

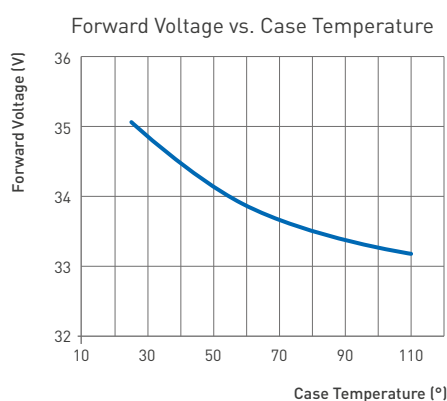
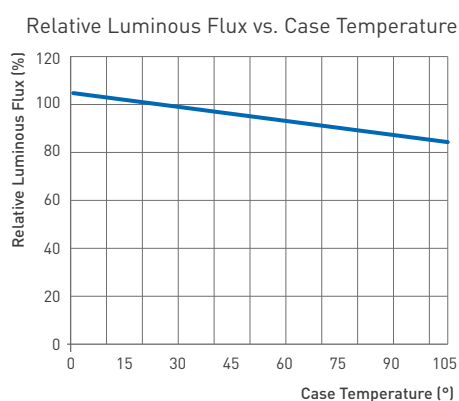
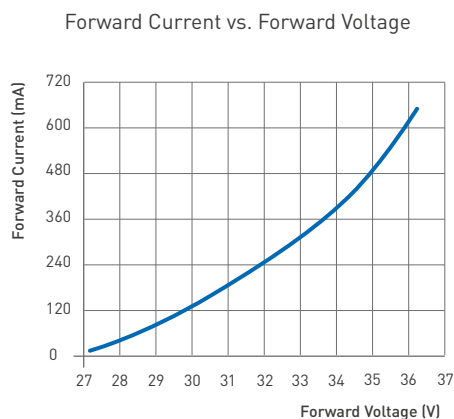
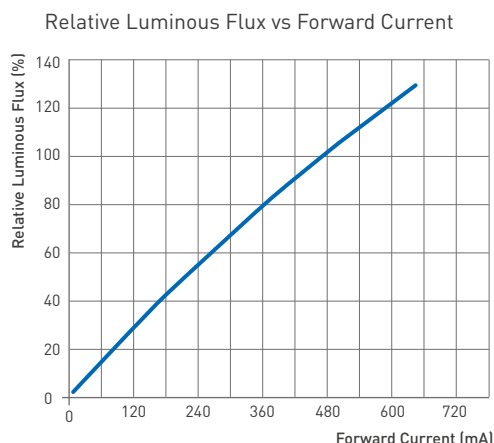

OPTICAL CURVES

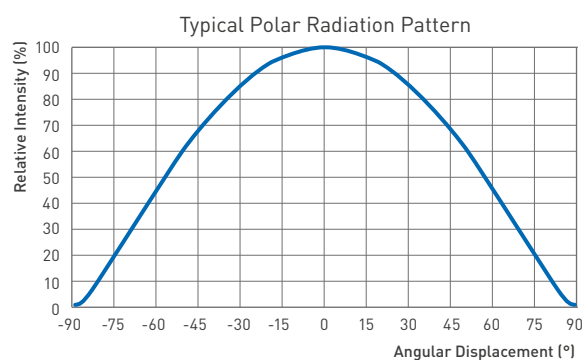
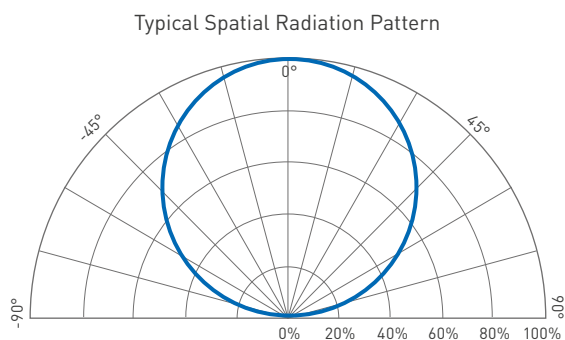

Typical viewing angle is 120°. The viewing angle is defined as the off axis angle from the center line where intensity is 1/2 of the peak value.

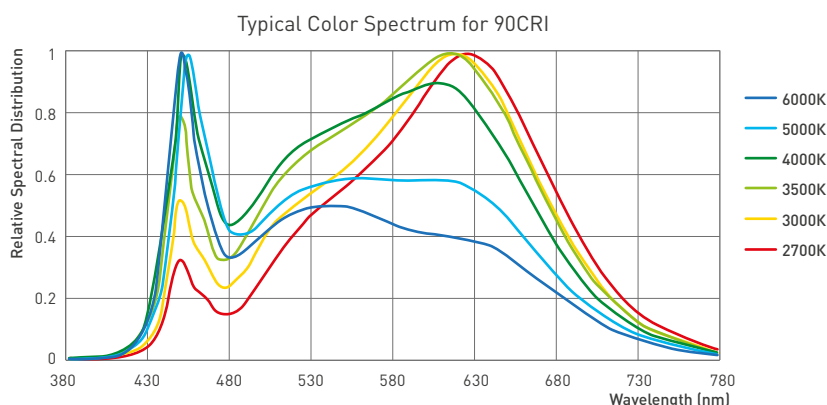

1. Color spectra measured at nominal current for $T_j = T_c = 25^\circ\text{C}$.
2. Color spectra shown is 2700K and 6000K with CRI90.

RELIABILITY TEST

Test Item	REF. Standard	Test condition	Sample quantity	Failure quantity
Thermal Shock	JESD22-A104E	-40 °C (15min) ~ 120 °C (15min), 200 cycles	22	0
High Temperature Storage	JESD22-A103D	Ta=100 °C, 1000h	22	0
Low Temperature Storage	JESD22-A119	Ta=-40 °C, 1000h	22	0
Temperature, High Humidity, Aging Test	JESD22-A101C	Ta=85 °C, RH>=85%, IF=480mA 1000h	22	0
High-temperature operation	IES LM80-2015	Ta=105 °C, IF=480mA 1000h	22	0
Low temperature operation	JESD22-A108D	T=40 °C, IF=480mA 1000h	22	0
Moisture/Reflow Sensitivity Test	J-STD-020E	Precondition: 60 °C, 60%RH, 168H Tsltd=260 °C. 10sec. 3 Reflows	22	0