

# ВЫВОДНОЙ СВЕТОДИОД КРУГЛЫЙ

**ARL-5313UWC-22cd WarmWhite**

## FEATURES

- High efficiency
- Low power consumption
- General purpose leads
- Selected minimum intensities
- Available on tape and reel
- Pb free

## DESCRIPTIONS

- The series is specially designed for applications requiring higher brightness.
- The LED lamps are available with different colors, intensities, epoxy colors, etc.
- Superior performance in outdoor environment.

## APPLICATIONS

- Status indicators
- Commercial use
- Advertising signs
- Back lighting

## DEVICE SELECTION GUIDE

LED Part No.	CHIP		Lens Color
	Material	Emitted Color	
<b>ARL-5313UWC-22cd</b>	<b>InGaN</b>	<b>White</b>	<b>Water clear</b>



5 mm



TRANSPARENT

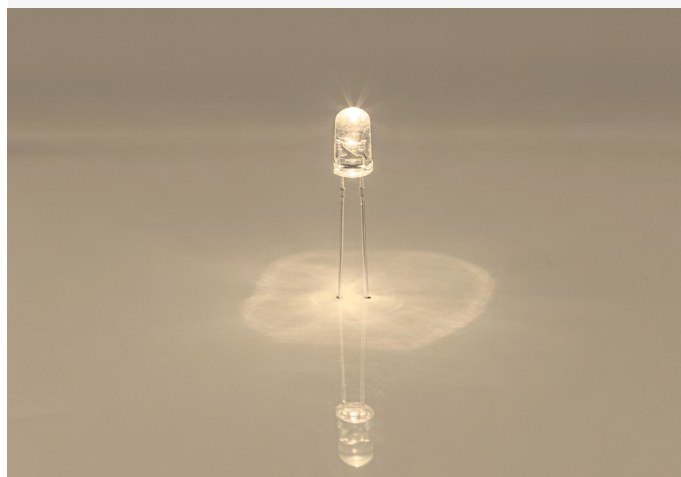

The ultra bright LED is an electrostatic insensitive device, so static electricity and surge will damage the LED. It is required to wear a wristband when handling the LED. All device, equipment, machinery, desk and ground must be properly grounded. When using LED, it must use a protective resistor in series with DC current about 20mA.



**ATTENTION!**  
**ELECTROSTATIC SENSITIVE DEVICES.**  
OBSERVE PRECAUTIONS FOR HANDLING.

## PACKAGE DIMENSIONS

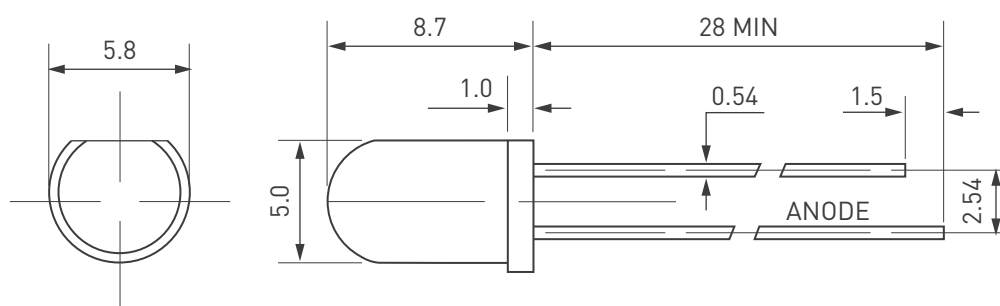

Unit: mm.

### Notes:

Other dimensions are in millimeters, tolerance is 0.25mm except being specified.

Protruded resin under flange is 1.5mm, Max LED.

Bare copper alloy is exposed at tie-bar portion after cutting.

## ABSOLUTE MAXIMUM RATING $(T_A = +25^\circ\text{C})$

Parameter	Symbol	Absolute Maximum Rating	Unit
Reverse Voltage	$V_R$	5	V
Operating Temperature	$T_{opr}$	-40... +80	°C
Storage Temperature	$T_{stg}$	-40... +100	°C
Soldering Heat (5s)	$T_{sol}$	260	°C

## ELECTRO-OPTICAL CHARACTERISTICS $(T_A = +25^\circ\text{C})$

Parameter	Symbol	Min.	Typ.	Max.	Unit	Test Condition
Luminous Intensity	$I_v$	20000	—	22000	mcd	$I_f=20\text{mA}$ (Note 1)
Viewing Angle	$2\theta_{1/2}$	—	30	—	Deg	Note 2
Peak Emission Wavelength	$\lambda_P$	2800–33000K			CCT(K)	$I_f=20\text{mA}$
Spectral Line Half-Width	$\Delta\lambda$	25	30	35	nm	$I_f=20\text{mA}$
Forward Voltage	$V_F$	2.9	—	3.5	V	$I_f=20\text{mA}$
Reverse Current	$I_R$	—	—	10	$\mu\text{A}$	$V_R=5\text{V}$

### Note:

1. Luminous intensity is measured with a light sensor and filter combination that approximates the CIE eye-response curve.

2.  $\theta_{1/2}$  is the off-axis angle at which the luminous intensity is half the axial luminous intensity.

# TYPICAL ELECTRO-OPTICAL CHARACTERISTICS CURVES

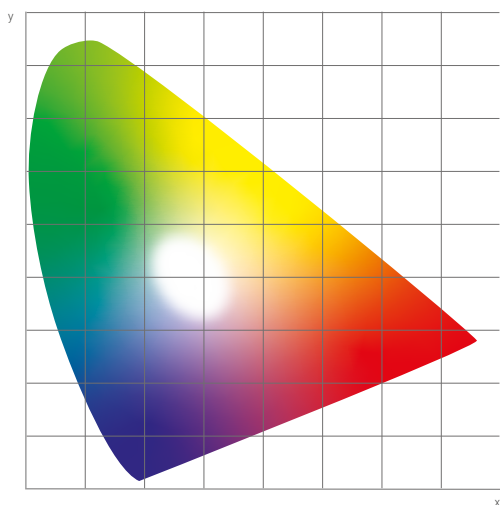

**Forward Current VS Forward Voltage**

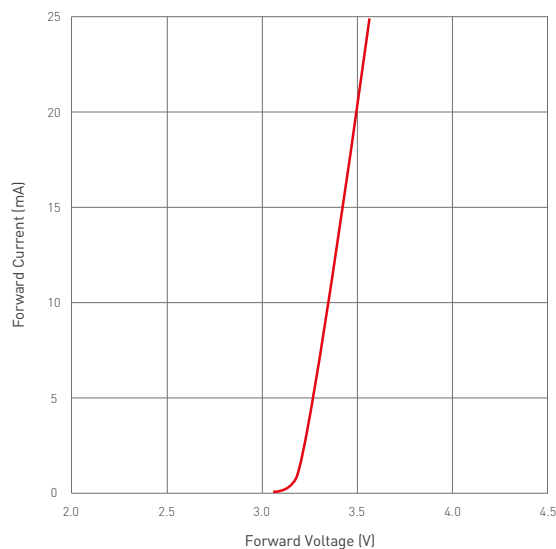

**Relative Intensity VS Ambient Temp**

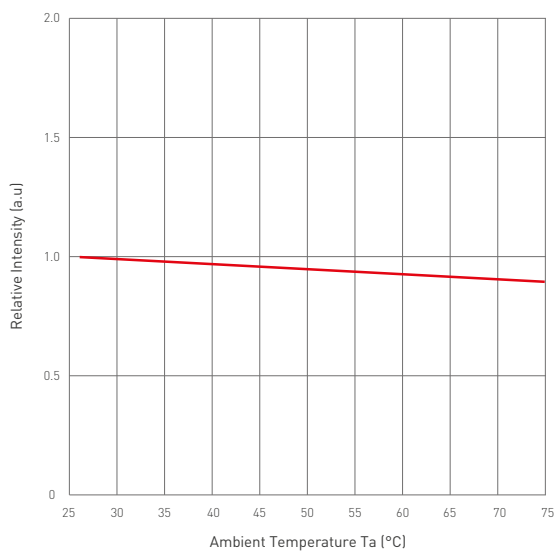

**Forward Current VS Relative Intensity**

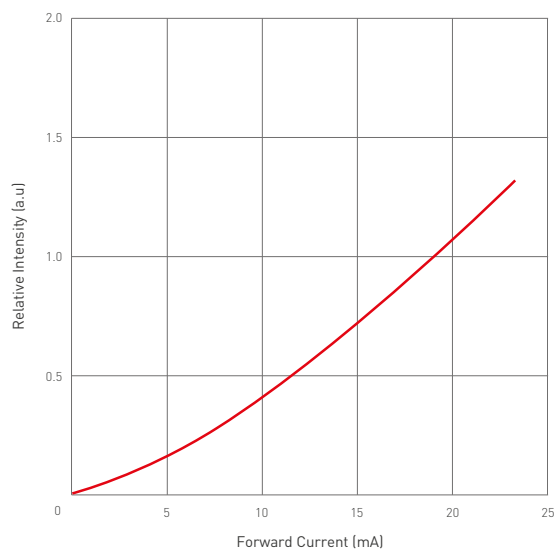

**Forward Current VS Ambient Temp**

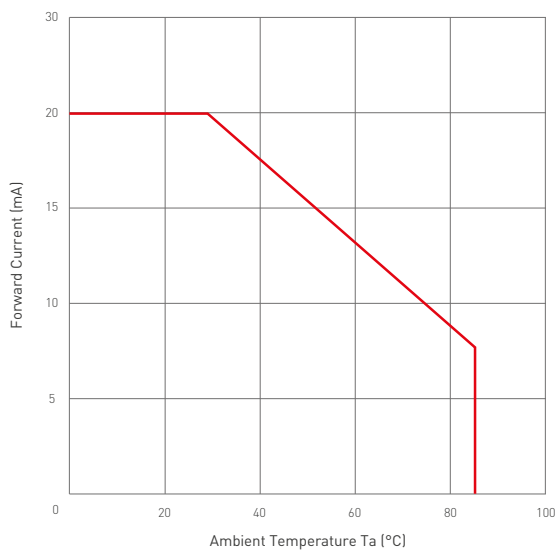

**Radiation Characteristics**

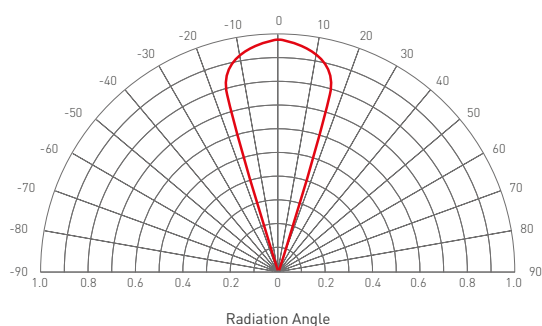

## NOTES

1. Above specification may be changed without notice. Will reserve authority on material change for above specification.
2. When using this product, please observe the absolute maximum ratings and the instructions for using outlined in these specification sheets. Assumes no responsibility for any damage resulting from use of the product which does not comply with the absolute maximum ratings and the instructions included in these specification sheets.
3. These specification sheets include materials protected under copyright of the corporation. Please don't reproduce or cause anyone to reproduce them without consent.